

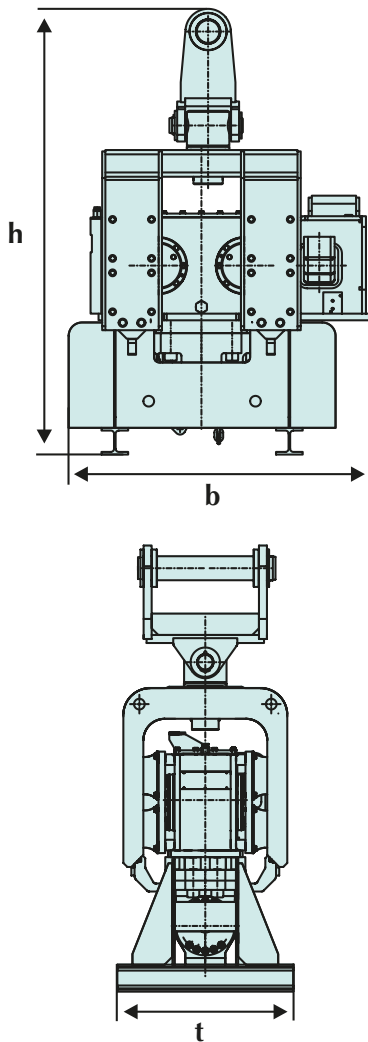

ABI Add-on Vibrators HVR

For smaller projects ABI offers attachments for hydraulic excavators. The **add-on vibrator HVR** is mounted at the dipper stick of a hydraulic excavator boom and driven by its hydraulic system.

Apart from characteristics like very short starting and stopping times, high revolutions, **low noise level** as well as **low weight** and **high centrifugal forces**, the HVR is characterised by a **short design height**. This advantage appears particularly in buildings, under bridges or power lines. Little usable length is lost due to its small design height. The add-on vibrator is used for **piling and extracting sheet piles, trench sheets, steel beams and girders, pipes and casings** as well as **full displacement sections**.



ABI Add-on Vibrator HVR 45

Technical data	Unit	HVR 45
Static moment	kgm	4,5
Dynamic mass	kg	740
Nominal revolutions	min ⁻¹	2460
Centrifugal force at nominal frequency	kN	300
Static extraction force max.	kN	40
Nominal oil pressure	MPa	32
Hydraulic flow rate	l/min	130
Hydraulic power at p max.	kW	70
Total weight / transport weight	kg	1100/1185
Weight of pile elements	kg	800

Dimension / mm	HVR 45
H Height	1595
B Width	1050
T Depth	615
S Locking to bottom	1160
X Locking to vibrator body	780
Z Excavator connection standard	352
Transport dimensions h / b / t	1670/1135/660